

# NNU41/800S.M

Zylinderrollenlager (zweireihig, mit Käfig)



## Details:

### Hauptabmessungen

d [mm]	800	$D_1$ [mm]	≈ 1129
D [mm]	1280	$d_s$ [mm]	12,5
B [mm]	475	$n_s$ [mm]	23,5
Gewicht [kg]	≈ 2385	$r_{1,2}$ [mm]	9,5
		s [mm]	18,6
F [mm]	921		

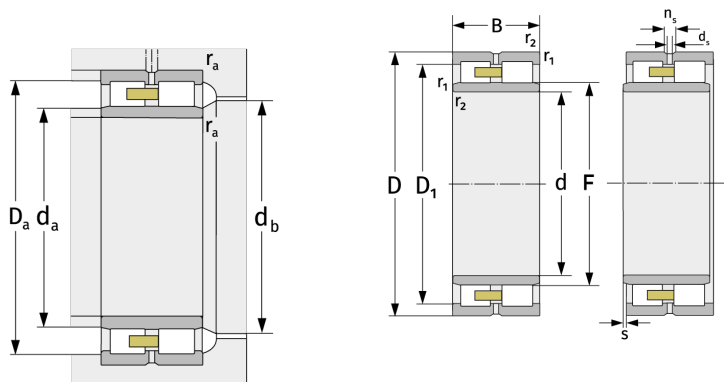

Anschlussmaße		Berechnungsdaten	
$d_{a, \min}$ [mm]	840	C [kN]	17100
$d_{a, \max}$ [mm]	912	$C_0$ [kN]	38200
$d_{b, \min}$ [mm]	926	$C_u$ [kN]	2660
$D_{a, \max}$ [mm]	1240	$n_{G, \text{Fett}}$ [ $\text{min}^{-1}$ ]	450
$r_{a, \max}$ [mm]	8	$n_{G, \text{Öl-Luft}}$ [ $\text{min}^{-1}$ ]	530