

NNU4156S.M

Zylinderrollenlager (zweireihig, mit Käfig)



Details:

Hauptabmessungen

d [mm]	280	D_1 [mm]	$\approx 402,8$
D [mm]	460	d_s [mm]	12,5
B [mm]	180	n_s [mm]	23,5
Gewicht [kg]	≈ 120	$r_{1,2}$ [mm]	5
F [mm]	326	s [mm]	6,3

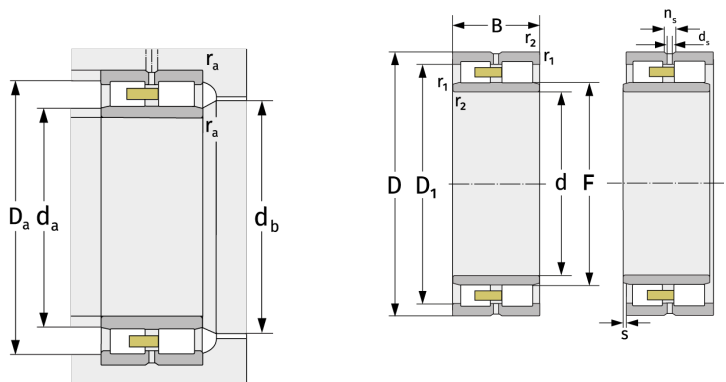

Anschlussmaße		Berechnungsdaten	
$d_{a, \min}$ [mm]	300	C [kN]	2560
$d_{a, \max}$ [mm]	323	C_0 [kN]	4790
$d_{b, \min}$ [mm]	329	C_u [kN]	448
$D_{a, \max}$ [mm]	440	$n_{G, \text{Fett}}$ [min^{-1}]	1700
$r_{a, \max}$ [mm]	4	$n_{G, \text{Öl-Luft}}$ [min^{-1}]	1900