

NNU4164S.M

Zylinderrollenlager (zweireihig, mit Käfig)



Details:

Hauptabmessungen

d [mm]	320	D_1 [mm]	≈ 471
D [mm]	540	d_s [mm]	12,5
B [mm]	218	n_s [mm]	23,5
Gewicht [kg]	≈ 204	$r_{1,2}$ [mm]	5
F [mm]	375	s [mm]	8,9

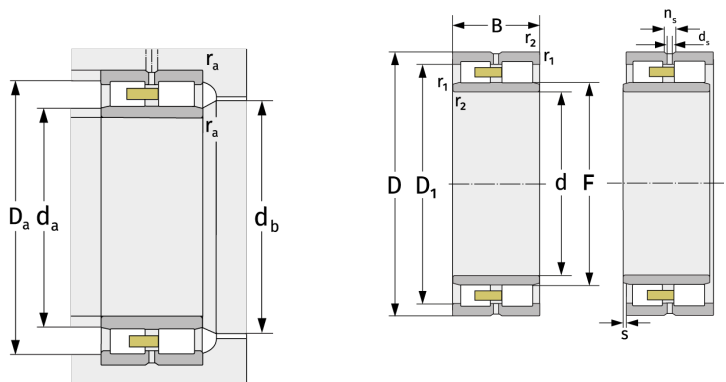

Anschlussmaße		Berechnungsdaten	
$d_{a, \min}$ [mm]	340	C [kN]	3430
$d_{a, \max}$ [mm]	371	C_0 [kN]	6300
$d_{b, \min}$ [mm]	379	C_u [kN]	565
$D_{a, \max}$ [mm]	520	$n_{G, \text{Fett}}$ [min^{-1}]	1400
$r_{a, \max}$ [mm]	4	$n_{G, \text{Öl-Luft}}$ [min^{-1}]	1600