

NNU4856S.M

Zylinderrollenlager (zweireihig, mit Käfig)



Details:

Hauptabmessungen

d [mm]	280	D_1 [mm]	$\approx 326,4$
D [mm]	350	d_s [mm]	4,8
B [mm]	69	n_s [mm]	9,5
Gewicht [kg]	≈ 15	$r_{1,2}$ [mm]	2
		s [mm]	3,5
F [mm]	302		

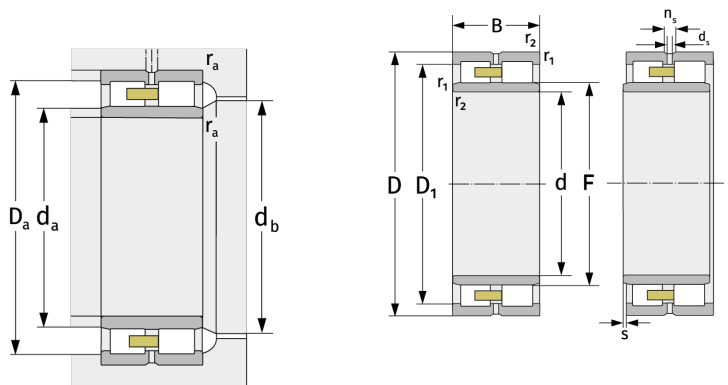

Anschlussmaße		Berechnungsdaten	
$d_{a, \min}$ [mm]	289	C [kN]	498
$d_{a, \max}$ [mm]	300	C_0 [kN]	1350
$d_{b, \min}$ [mm]	305	C_u [kN]	133
$D_{a, \max}$ [mm]	341	$n_{G, \text{Fett}}$ [min^{-1}]	2000
$r_{a, \max}$ [mm]	2	$n_{G, \text{Öl-Luft}}$ [min^{-1}]	2300