

NNU4860S.M

Zylinderrollenlager (zweireihig, mit Käfig)



Details:

Hauptabmessungen

d [mm]	300	D_1 [mm]	$\approx 350,6$
D [mm]	380	d_s [mm]	4,8
B [mm]	80	n_s [mm]	9,5
Gewicht [kg]	$\approx 22,4$	$r_{1,2}$ [mm]	2,1
		s [mm]	4,8
F [mm]	325		

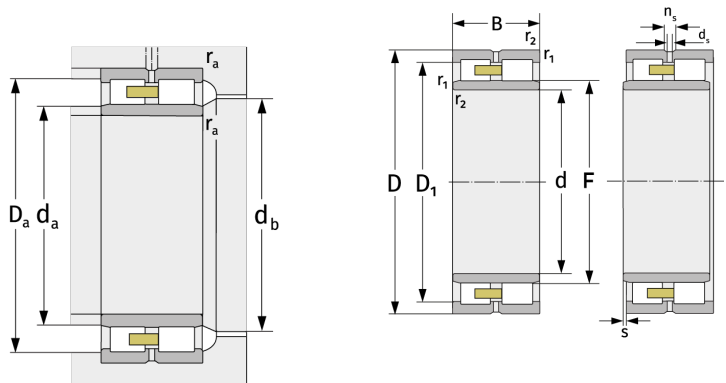

Anschlussmaße		Berechnungsdaten	
$d_{a, \min}$ [mm]	310	C [kN]	590
$d_{a, \max}$ [mm]	322	C_0 [kN]	1570
$d_{b, \min}$ [mm]	328	C_u [kN]	151
$D_{a, \max}$ [mm]	370	$n_{G, \text{Fett}}$ [min^{-1}]	1800
$r_{a, \max}$ [mm]	2,1	$n_{G, \text{Öl-Luft}}$ [min^{-1}]	2200