

NNU4872S.M

Zylinderrollenlager (zweireihig, mit Käfig)



Details:

Hauptabmessungen

d [mm]	360	D_1 [mm]	$\approx 411,6$
D [mm]	440	d_s [mm]	4,8
B [mm]	80	n_s [mm]	9,5
Gewicht [kg]	$\approx 26,4$	$r_{1,2}$ [mm]	2,1
		s [mm]	4,8
F [mm]	386		

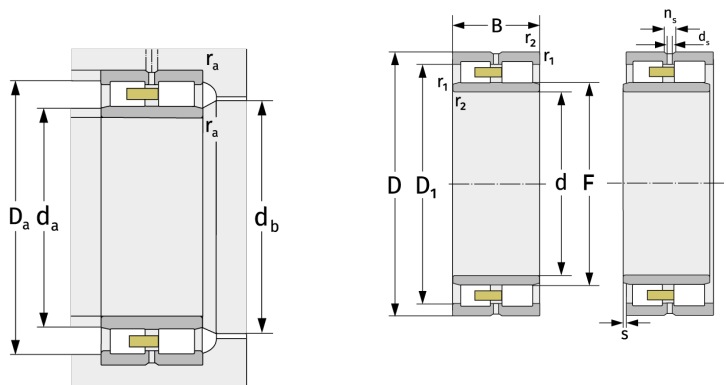

Anschlussmaße		Berechnungsdaten	
$d_{a, \min}$ [mm]	370	C [kN]	670
$d_{a, \max}$ [mm]	383	C_0 [kN]	1950
$d_{b, \min}$ [mm]	390	C_u [kN]	179
$D_{a, \max}$ [mm]	430	$n_{G, \text{Fett}}$ [min^{-1}]	1500
$r_{a, \max}$ [mm]	2,1	$n_{G, \text{Öl-Luft}}$ [min^{-1}]	1800