

NNU49/530S.M

Zylinderrollenlager (zweireihig, mit Käfig)



Details:

Hauptabmessungen

d [mm]	530	D_1 [mm]	≈ 652
D [mm]	710	d_s [mm]	9,5
B [mm]	180	n_s [mm]	17,7
Gewicht [kg]	≈ 205	$r_{1,2}$ [mm]	5
		s [mm]	7,5
F [mm]	588		

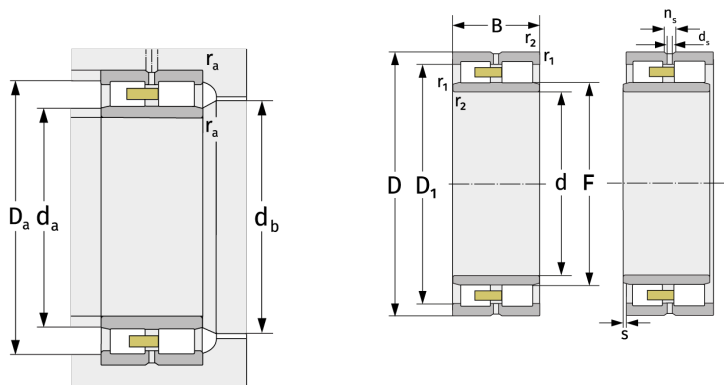

Anschlussmaße		Berechnungsdaten	
$d_{a, \min}$ [mm]	548	C [kN]	2960
$d_{a, \max}$ [mm]	584	C_0 [kN]	7850
$d_{b, \min}$ [mm]	592	C_u [kN]	635
$D_{a, \max}$ [mm]	692	$n_{G, \text{Fett}}$ [min^{-1}]	880
$r_{a, \max}$ [mm]	4	$n_{G, \text{Öl-Luft}}$ [min^{-1}]	1100