

NNU49/900S.M

Zylinderrollenlager (zweireihig, mit Käfig)



Details:

Hauptabmessungen

d [mm]	900	D_1 [mm]	≈
D [mm]	1180		1088,4
B [mm]	280	d_s [mm]	12,5
Gewicht [kg]	≈ 830	n_s [mm]	23,5
		$r_{1,2}$ [mm]	6
F [mm]	986	s [mm]	12,5

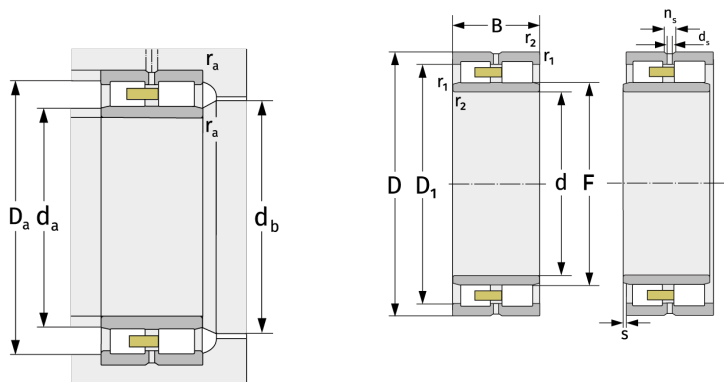

Anschlussmaße		Berechnungsdaten	
$d_{a, \min}$ [mm]	923	C [kN]	7200
$d_{a, \max}$ [mm]	979	C_0 [kN]	21000
$d_{b, \min}$ [mm]	991	C_u [kN]	1470
$D_{a, \max}$ [mm]	1157	$n_{G, \text{Fett}}$ [min^{-1}]	450
$r_{a, \max}$ [mm]	5	$n_{G, \text{Öl-Luft}}$ [min^{-1}]	530