

# NNU4960S.M

Zylinderrollenlager (zweireihig, mit Käfig)



## Details:

### Hauptabmessungen

d [mm]	300	$D_1$ [mm]	≈ 379
D [mm]	420	$d_s$ [mm]	9,5
B [mm]	118	$n_s$ [mm]	17,7
Gewicht [kg]	≈ 51,9	$r_{1,2}$ [mm]	3
		s [mm]	6,3
F [mm]	339		

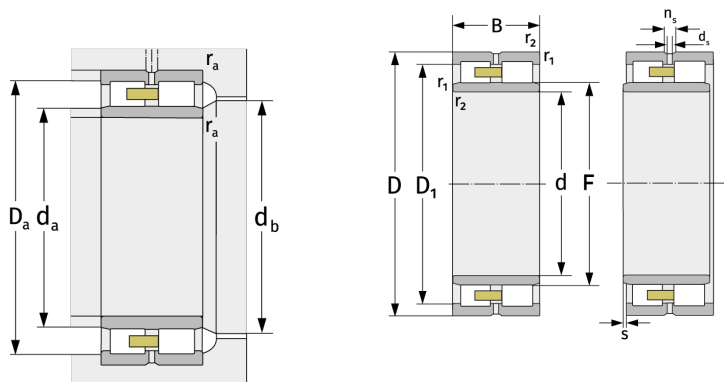

Anschlussmaße		Berechnungsdaten	
$d_{a, \min}$ [mm]	312	C [kN]	1070
$d_{a, \max}$ [mm]	335	$C_0$ [kN]	2470
$d_{b, \min}$ [mm]	342	$C_u$ [kN]	233
$D_{a, \max}$ [mm]	408	$n_{G, \text{Fett}}$ [ $\text{min}^{-1}$ ]	1700
$r_{a, \max}$ [mm]	2,5	$n_{G, \text{Öl-Luft}}$ [ $\text{min}^{-1}$ ]	2000