

# NNU4968S.M

Zylinderrollenlager (zweireihig, mit Käfig)



## Details:

### Hauptabmessungen

d [mm]	340	$D_1$ [mm]	≈ 419
D [mm]	460	$d_s$ [mm]	9,5
B [mm]	118	$n_s$ [mm]	17,7
Gewicht [kg]	≈ 57,7	$r_{1,2}$ [mm]	3
		s [mm]	6,3
F [mm]	379		

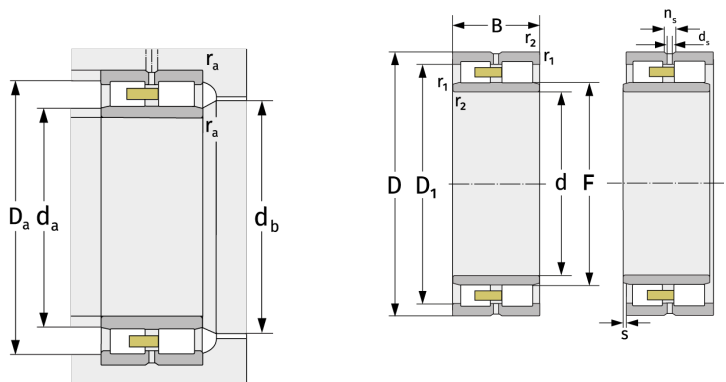

Anschlussmaße		Berechnungsdaten	
$d_{a, \min}$ [mm]	352	C [kN]	1140
$d_{a, \max}$ [mm]	375	$C_0$ [kN]	2770
$d_{b, \min}$ [mm]	383	$C_u$ [kN]	254
$D_{a, \max}$ [mm]	448	$n_{G, \text{Fett}}$ [ $\text{min}^{-1}$ ]	1500
$r_{a, \max}$ [mm]	2,5	$n_{G, \text{Öl-Luft}}$ [ $\text{min}^{-1}$ ]	1800