

NNU6056M

Zylinderrollenlager (mehrrichtig, mit Käfig)



Details:

Hauptabmessungen

d [mm]	280	d_s [mm]	4,8
D [mm]	420	n_s [mm]	9,5
B [mm]	250	$r_{1,2}$ [mm]	4
Gewicht [kg]	≈ 128	$r_{3,4}$ [mm]	4
		s [mm]	7
F [mm]	321,5		
D_1 [mm]	≈ 366,3		

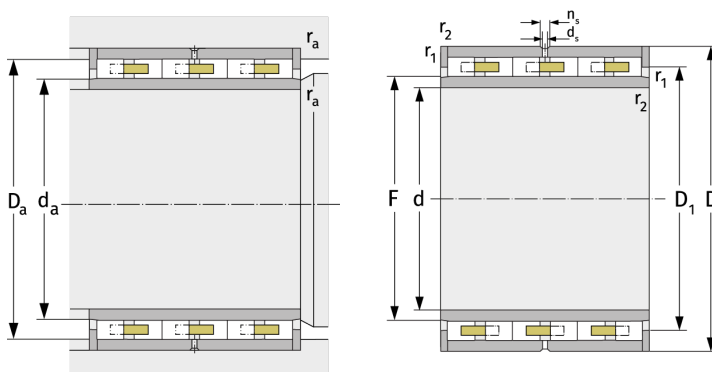

Anschlussmaße		Berechnungsdaten	
$d_{a, \min}$ [mm]	319	C [kN]	2200
$D_{a, \max}$ [mm]	405	C_0 [kN]	5700
$r_{a, \max}$ [mm]	3	C_u [kN]	543
$r_{b, \max}$ [mm]	3	n_g [min ⁻¹]	1600