

NNU6926M

Zylinderrollenlager (mehrrichtig, mit Käfig)



Details:

Hauptabmessungen

d [mm]	130	d_s [mm]	3,2
D [mm]	180	n_s [mm]	6,5
B [mm]	90	$r_{1,2}$ [mm]	1,5
Gewicht [kg]	≈ 7,28	$r_{3,4}$ [mm]	1,5
		s [mm]	3
F [mm]	143,5		
D_1 [mm]	≈ 159,5		

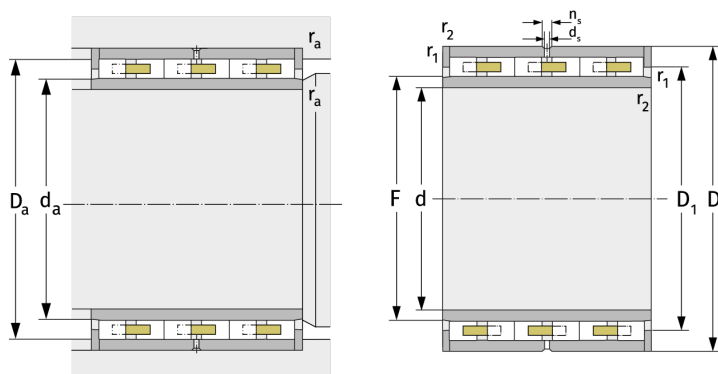

Anschlussmaße		Berechnungsdaten	
$d_{a, \min}$ [mm]	141	C [kN]	348
$D_{a, \max}$ [mm]	173	C_0 [kN]	845
$r_{a, \max}$ [mm]	1,5	C_u [kN]	102
$r_{b, \max}$ [mm]	1,5	n_g [min^{-1}]	3800