

NU248E.M3

Zylinderrollenlager (einreihig, mit Käfig)



Details:

Hauptabmessungen

d [mm]	240	D_1 [mm]	≈ 373
D [mm]	440	$r_{1,2}$ [mm]	4
B [mm]	72	$r_{3,4}$ [mm]	4
Gewicht [kg]	≈ 50	s [mm]	5
F [mm]	293		

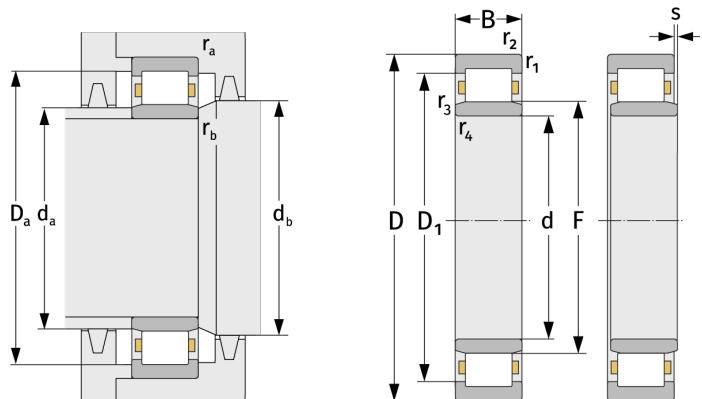

Anschlussmaße		Berechnungsdaten	
$d_{a, \min}$ [mm]	257	C [kN]	1140
$d_{a, \max}$ [mm]	290	C_0 [kN]	1590
$d_{b, \min}$ [mm]	296	C_u [kN]	152
$D_{a, \max}$ [mm]	423	n_{th} [min^{-1}]	1245
$r_{a, \max}$ [mm]	3	n_g [min^{-1}]	2000
$r_{b, \max}$ [mm]	3		