

# NU272E.M3

Zylinderrollenlager (einreihig, mit Käfig)



## Details:

### Hauptabmessungen

d [mm]	360	$D_1$ [mm]	$\approx 553,4$
D [mm]	650	$r_{1,2}$ [mm]	6
B [mm]	95	$r_{3,4}$ [mm]	6
Gewicht [kg]	$\approx 146$	s [mm]	6,9
F [mm]	451		

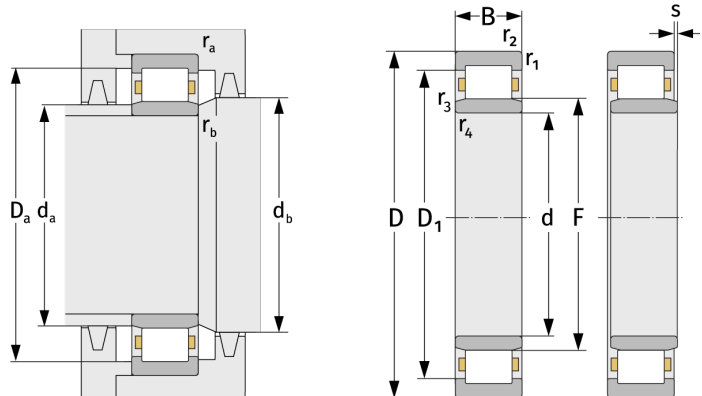

Anschlussmaße		Berechnungsdaten	
$d_{a, \min}$ [mm]	386	C [kN]	2060
$d_{a, \max}$ [mm]	448	$C_0$ [kN]	3280
$d_{b, \min}$ [mm]	455	$C_u$ [kN]	279
$D_{a, \max}$ [mm]	624	$n_{th}$ [ $\text{min}^{-1}$ ]	704
$r_{a, \max}$ [mm]	5	$n_g$ [ $\text{min}^{-1}$ ]	1300
$r_{b, \max}$ [mm]	5		