

NU3980E.M3

Zylinderrollenlager (einreihig, mit Käfig)



Details:

Hauptabmessungen

d [mm]	400	D_1 [mm]	$\approx 494,8$
D [mm]	540	$r_{1,2}$ [mm]	4
B [mm]	106	$r_{3,4}$ [mm]	4
Gewicht [kg]	$\approx 71,4$	s [mm]	5,7
F [mm]	434		

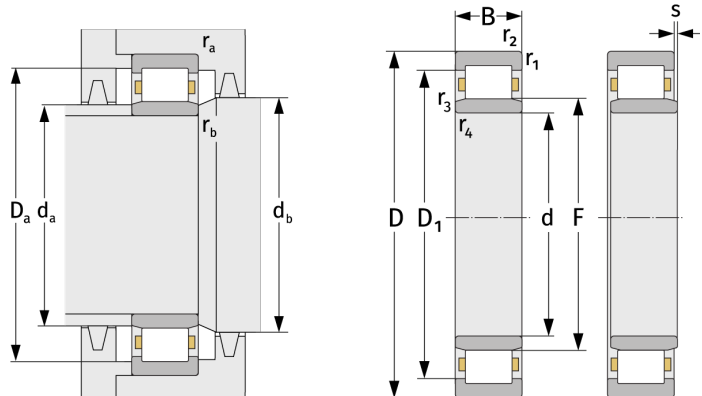

Anschlussmaße		Berechnungsdaten	
$d_{a, \min}$ [mm]	414,6	C [kN]	1740
$d_{a, \max}$ [mm]	430	C_0 [kN]	3740
$d_{b, \min}$ [mm]	438	C_u [kN]	326
$D_{a, \max}$ [mm]	525,4	n_{th} [min^{-1}]	658
$r_{a, \max}$ [mm]	3	n_g [min^{-1}]	1400
$r_{b, \max}$ [mm]	3		